

- Messbereiche: 100N, 200N
- Ausgangssignal (2mV/V)
- Druck- / Zugmessung
- robuster Aufbau bei kleinen Abmessungen
- Schutzart: IP65
  
- *measuring range:*  
100N and 200N
- *output (2mV/V)*
- *tension / compression*
- *rugged construction and small dimensions*
- *protection degree: IP65*

Inelta Kraftsensoren arbeiten mit Folien-Dehnungsmessstreifen (DMS).

*Inelta Force Sensors operate with foil strain gauges (DMS).*

### Anwendungen:

- Industrie und Labor
- Medizintechnik
- Wägetechnik
- Prüfanlagen
- Maschinen- und Anlagenbau
- Sportgeräte
- Abwicklerstationen
- Industriepressen

### Applications:

- *Industry and laboratory*
- *Medical technology*
- *Weighting systems*
- *Testing facility*
- *Engine and installation construction*
- *Pieces of sport equipment*
- *Winding machines*
- *Industrial presses*

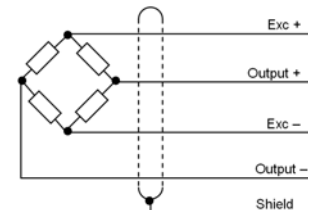

DMS Messbrücke  
DMS Wheatstonebridge

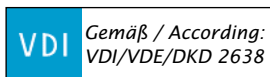

### Optionen / Options

- Andere Kabellänge auf Anfrage (Standard = 1m) / *Other cable length on request (standard = 1m)*
- Erweiterter Temperaturbereich (-40°C .. +120°C) / *Extended temperature range (-40°C .. +120°C)*
- Individuelle Kalibrierungen / *Individual calibration service*
- Sensorsignalverstärker (intern, extern) / *Signal conditioner (internal, external)*
- Weitere Optionen auf Anfrage / *More options on request*

<b>Technische Spezifikation / Technical Specification</b>			
Kraftmessbereich <i>Measuring range</i>	0,1	0,2	[kN]
Max.Gebrauchskraft <i>Service load</i>	120		[% F.S.]
Grenzkraft <i>Limit load</i>	150		[% F.S.]
Bruchlast <i>Breaking load</i>	300		[% F.S.]
Empfindlichkeit <i>Sensitivity</i>	2 ±15%		[mV/V]
Rel. Abweichung d. Nullsignals <i>Zero signal tolerance</i>	< 2		[% F.S.]
Rel. Linearitätsabweichung <i>Linearity</i>	< 0,25		[% F.S.]
Reproduzierbarkeit <i>Repeatability</i>	< 0,05		[% F.S.]
Kriechen (30 min) <i>Creep error (30 min)</i>	< 0,05		[% F.S.]
Hysteresis <i>Hysteresis</i>	< 0,15		[% F.S.]
Grenzfrequenz fg <i>Cut off frequency fg</i>	1000		[Hz]
Temp.einfluss auf Kennwert pro K <i>Temp. coefficient sensitivity</i>	< 0,005		[% F.S./°C]
Temp.einfluss auf Nullsignal pro K <i>Temp. coefficient zero point</i>	< 0,005		[% F.S./°C]
Grenzquerkraft (mechanisch) <i>Limit lateral load</i>	200		[% F.S.]
Nennmessweg <i>Measuring displacement nom.</i>	200		[µm]
<b>Elektrische Spezifikation / Electrical Specification</b>			
Speisespannung Nenn <i>Excitation voltage nom.</i>	5 (max. 7)		[V]
Eingangsimpedanz <i>Input impedance</i>	1000 ±10		[Ω]
Ausgangsimpedanz <i>Output impedance</i>	1000 ±3		[Ω]
Isolationswiderstand (bei 500 VDC) <i>Insulation resistance (at 500 VDC)</i>	> 5000		[MΩ]
<b>Mechanische Spezifikation / Mechanical Specification</b>			
Material, Messkörper <i>Material, gauging</i>	Stahl, vernickelt <i>Steel, nickel-plated</i>		
Messverfahren <i>Measuring methode</i>	DMS Messbrücke <i>DMS Wheatstonebridge</i>		
Gewicht <i>Weight</i>	~ 20		[g]

### Umgebungsbedingungen / Environments

Nenntemperaturbereich <i>Operation temperature</i>	-10 .. +70 (kompensiert: 0 .. +50)	[°C]
Lagerungstemperaturbereich <i>Storage temperature</i>	-20 .. +85	[°C]
Relative Luftfeuchte (nicht kondensierend) <i>Rel. humidity (not condensing)</i>	95	[% r.H.]
Schutzart <i>Protection degree</i>	IP65	

### Maßzeichnung / Drawing

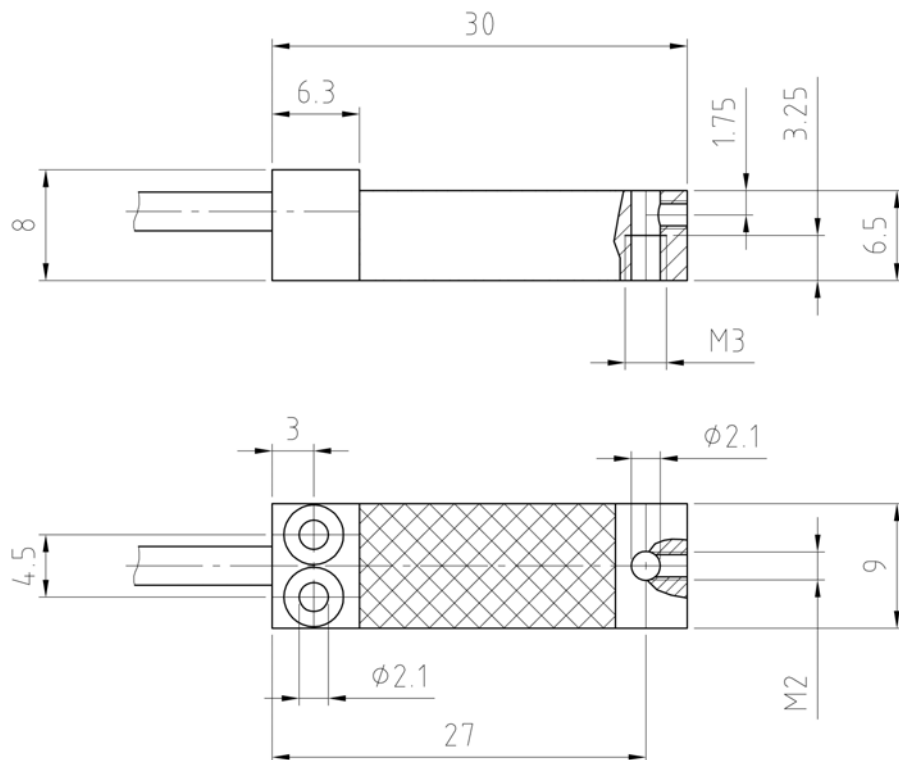





### Anschlussbelegung Kabel STC-31V-4RWBG, 4 x 0,004mm<sup>2</sup> (Kabellänge 1m) *Connection Cable STC-31V-4RWBG, 4 x 0,004 mm<sup>2</sup> (Cable length 1m)*

Kabelfarbe <i>Colour of cable</i>	Belegung <i>Configuration</i>
weiß <i>white</i>	+ Versorgung <i>+ Excitation</i>
grün <i>green</i>	- Versorgung <i>- Excitation</i>
rot <i>red</i>	+ Signal <i>+ Signal</i>
schwarz <i>black</i>	- Signal <i>- Signal</i>
Schirm <i>Shield</i>	Gehäuse <i>Housing</i>

Bestellcode / Order code		
Serie Series	Kraftmessbereich Measuring range	Präferenzrichtung Preference direction
FS12-	100N-	Z
Standard Standard	100N 200N	Z = Zug/Tension D = Druck/Compression

Zubehör / Accessories	 Datenblatt Datasheet <a href="http://www.inelta.de">www.inelta.de</a>
Zubehör auf Anfrage / Accessories on request	

Sensorsignal-Verstärker / Signal Conditioner	 Datenblatt Datasheet <a href="http://www.inelta.de">www.inelta.de</a>		
			
Serie / Series	IMA2-DMS	ISM-DMS	IVM2-DMS
Ausgangssignale / Output signals	0..5 V, 0..10 V, ±5 V, ±10 V, 0..20mA, 4..20 mA	0..10 V, 4..20 mA	0..10 V

Applikationsbeispiele und Benutzerhinweise / Application directions and user guide	 PDF Download <a href="http://www.inelta.de/service">www.inelta.de/service</a>
 <p>Die Broschüre zum Produkt mit Applikationsbeispielen und Benutzerhinweisen finden Sie im Internet unter <a href="http://www.inelta.de/service">www.inelta.de/service</a> Suitable for this product you can download the brochure with application directions and user guides under <a href="http://www.inelta.de/service">www.inelta.de/service</a></p>	